

794900-1 ✓ ACTIVE

MATE-N-LOK | Universal MATE-N-LOK

TE Internal #: 794900-1

Rectangular Power Connectors, Housing, Receptacle, Wire-to-Panel / Wire-to-Wire, 3 Position, 6.35 mm [.25 in] Centerline, Universal MATE-N-LOK

[View on TE.com >](#)



Connectors > Power Connectors > Rectangular Power > Rectangular Power Connectors

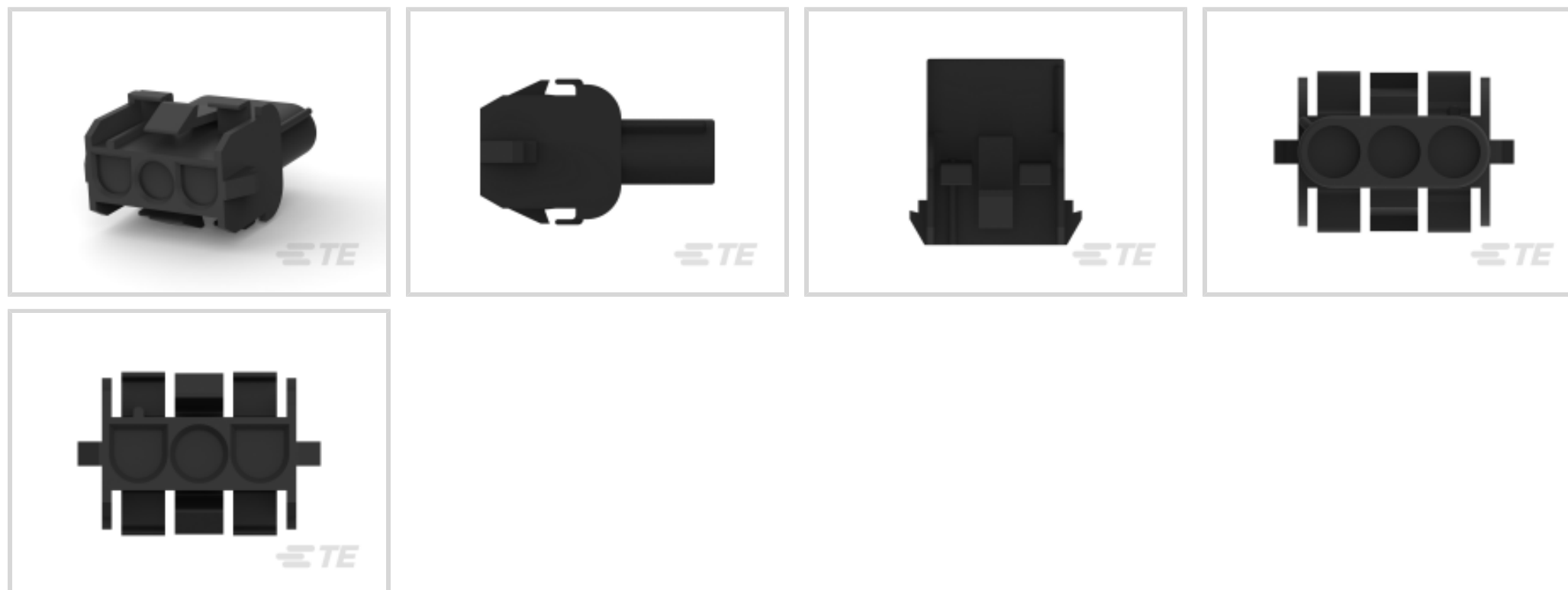

Rectangular Power Connector Type: **Housing**

Connector & Housing Type: **Receptacle**

Connector System: **Wire-to-Panel, Wire-to-Wire**

Number of Positions: **3**

Centerline (Pitch): **6.35 mm [.25 in]**

## Features

### Product Type Features

Rectangular Power Connector Type	Housing
Connector & Housing Type	Receptacle
Connector System	Wire-to-Panel, Wire-to-Wire
Sealable	No
Connector & Contact Terminates To	Wire & Cable

### Configuration Features

Number of Positions	3
Number of Rows	1

### Electrical Characteristics

Operating Voltage	600 VAC
-------------------	---------

### Contact Features

Contact Layout	Inline
Multiple Contact Types	Without
Contact Retention Within Housing	Without



Contact Type	Pin
--------------	-----

### Termination Features

Termination Method to Wire & Cable	Crimp
------------------------------------	-------

### Mechanical Attachment

Panel Mount Feature	With
---------------------	------

Panel Mount Feature Type	Latches
--------------------------	---------

Connector Mounting Type	Panel Mount
-------------------------	-------------

### Housing Features

Centerline (Pitch)	6.35 mm [.25 in]
--------------------	------------------

Housing Color	Black
---------------	-------

Housing Material	Nylon
------------------	-------

### Dimensions

Panel Thickness	.76 – 2.29 mm [.76 – 2.29 in]
-----------------	-------------------------------

### Usage Conditions

Operating Temperature Range	-55 – 125 °C [-67 – 257 °F]
-----------------------------	-----------------------------

### Operation/Application

Assembly Integration Feature	Without
------------------------------	---------

Circuit Application	Power & Signal
---------------------	----------------

### Industry Standards

CSA Rating	Certified
------------	-----------

UL Flammability Rating	UL 94V-2
------------------------	----------

Glow Wire Rating	Standard Part - Not Glow Wire
------------------	-------------------------------

Agency/Standard Number	E28476
------------------------	--------

Agency/Standard	CSA, UL
-----------------	---------

UL Rating	Recognized
-----------	------------

CSA File Number	LR7189
-----------------	--------

VDE Tested	Yes
------------	-----

### Packaging Features

Packaging Method	Package
------------------	---------

Packaging Quantity	1
--------------------	---

### Other



For Use With Appropriate Universal MATE-N-LOK Plug

### Product Compliance

[For compliance documentation, visit the product page on TE.com>](#)

EU RoHS Directive 2011/65/EU	Compliant
EU ELV Directive 2000/53/EC	Compliant
China RoHS 2 Directive MIIT Order No 32, 2016	No Restricted Materials Above Threshold
EU REACH Regulation (EC) No. 1907/2006	Current ECHA Candidate List: JUNE 2022 (224) Candidate List Declared Against: JUNE 2022 (224) Does not contain REACH SVHC
Halogen Content	Low Halogen - Br, Cl, F, I < 900 ppm per homogenous material. Also BFR/CFR/PVC Free
Solder Process Capability	Not applicable for solder process capability

#### Product Compliance Disclaimer

This information is provided based on reasonable inquiry of our suppliers and represents our current actual knowledge based on the information they provided. This information is subject to change. The part numbers that TE has identified as EU RoHS compliant have a maximum concentration of 0.1% by weight in homogenous materials for lead, hexavalent chromium, mercury, PBB, PBDE, DBP, BBP, DEHP, DIBP, and 0.01% for cadmium, or qualify for an exemption to these limits as defined in the Annexes of Directive 2011/65/EU (RoHS2). Finished electrical and electronic equipment products will be CE marked as required by Directive 2011/65/EU. Components may not be CE marked. Additionally, the part numbers that TE has identified as EU ELV compliant have a maximum concentration of 0.1% by weight in homogenous materials for lead, hexavalent chromium, and mercury, and 0.01% for cadmium, or qualify for an exemption to these limits as defined in the Annexes of Directive 2000/53/EC (ELV). Regarding the REACH Regulation, the information TE provides on SVHC in articles for this part number is based on the latest European Chemicals Agency (ECHA) 'Guidance on requirements for substances in articles' posted at this URL: <https://echa.europa.eu/guidance-documents/guidance-on-reach>

### Compatible Parts

 <p>TE Part # 3-643228-0 03P UMNL HDR ASSY R/A 94VO LF</p>	 <p>TE Part # 643228-1 03P UMNL HDR ASSY R/A 94VO</p>	 <p>TE Part # 3-350943-0 03P UMNL HDR ASSY R/A 94VO LF</p>	 <p>TE Part # 350790-1 03P UMNL PIN HDR ASSY 94VO</p>
---	---	---	--



TE Part # 350789-3  
03P UMNL PIN HDR ASSY 94VO



TE Part # 173925-1  
3 P ACTION PIN UMNL



TE Part # 1-350766-2  
03P UMNL V0 PLUG HSG RED



TE Part # 1-480701-4  
03P UMNL CAP HSG YELL



TE Part # 1-480703-9  
04P UMNL CAP HSG BLK



TE Part # 1-350943-0  
03P UMNL HDR ASSY R/A 94VO



TE Part # 1-480700-2  
03P UMNL PLUG HSG RED



TE Part # 641965-1  
03P UMNL PIN HDR ASSY V2 NATL



TE Part # 770018-1  
03P UMNLII IN-LNE PLUG HSG KIT



TE Part # 350789-1  
03P UMNL PIN HDR ASSY 94VO



TE Part # 1-480701-2  
03P UMNL CAP HSG RED

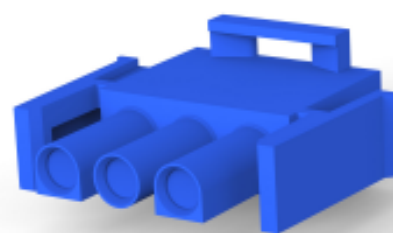

TE Part # 1-480700-6  
03P UMNL PLUG HSG BLU



TE Part # 350760-4  
03P UMNL HDR ASSY PC



TE Part # 2-480700-0  
03P UMNL PLUG HSG



TE Part # 350429-1  
03P UMNL PIN HDR ASSY NATL



TE Part # 1586077-1  
03P UMNL PIN HDR ASSY W/O DRNS

Also in the Series | **Universal MATE-N-LOK**



Circular Power Connectors(2)



Connector Contacts(11)



Insertion & Extraction Tools(4)



Power Contacts(207)

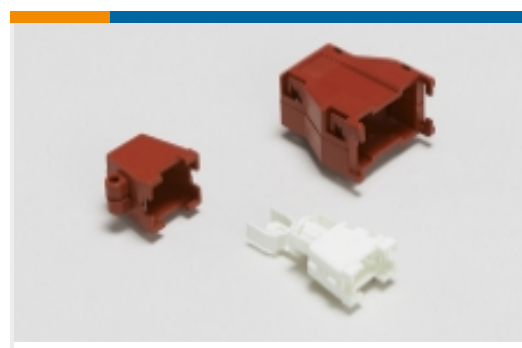

Rectangular Boots &amp; Strain Relief(35)

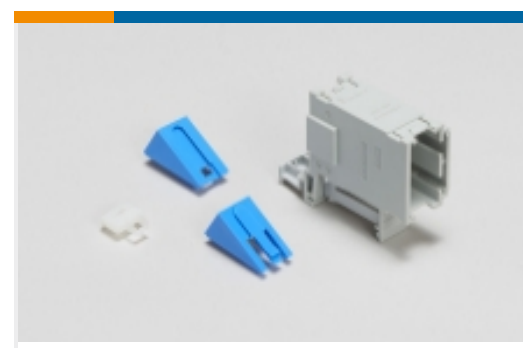

Rectangular Connector Adapters(7)

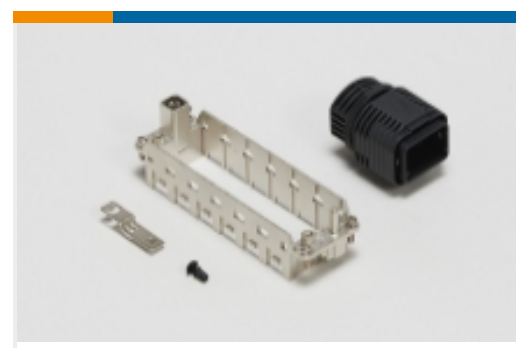

Rectangular Connector Hardware(1)



Rectangular Connector Housings(2)



Rectangular Connector Keying Plugs(3)



Rectangular Connector Locking(4)

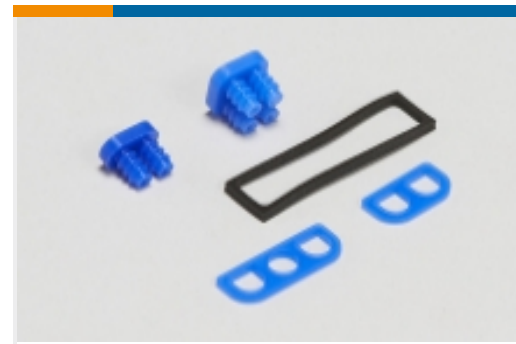

Rectangular Connector Seals(26)



Rectangular Power Connectors(728)

## Documents

### Product Drawings

[03P UMNL HI TEMP CAP HSG](#)

English

### CAD Files

[3D PDF](#)

3D

Customer View Model

[ENG\\_CVM\\_CVM\\_794900-1\\_A\\_c-794900-1-a.2d\\_dxf.zip](#)

English

Customer View Model

[ENG\\_CVM\\_CVM\\_794900-1\\_A\\_c-794900-1-a.3d\\_igs.zip](#)

English

Customer View Model

[ENG\\_CVM\\_CVM\\_794900-1\\_A\\_c-794900-1-a.3d\\_stp.zip](#)

English

By downloading the CAD file I accept and agree to the [Terms and Conditions](#) of use.

### Datasheets & Catalog Pages

[SOFT\\_SHELL\\_PIN\\_SOCKET\\_CONNECTORS\\_STANDARD\\_DENSITY](#)

English

### Product Environmental Compliance

[MD\\_794900-1\\_061120181018\\_dmtec](#)

English

[MD\\_794900-1\\_061120181018\\_dmtec](#)

English



---

[Agency Approvals](#)

[VDE Certificate](#)

English